

EAST WEST CORPORATION LIMITED

Address: Grandmark Room 404, No.10 Granville road, TSIM SHA TSUI
Kowloon, Hong Kong

TEL. + (852) 2424 8088 Skype "filandarth"

Email : cbgeorge@biznetvigator.com Website: WWW.EWCLCHINA.COM



Doing business with the world since 1968

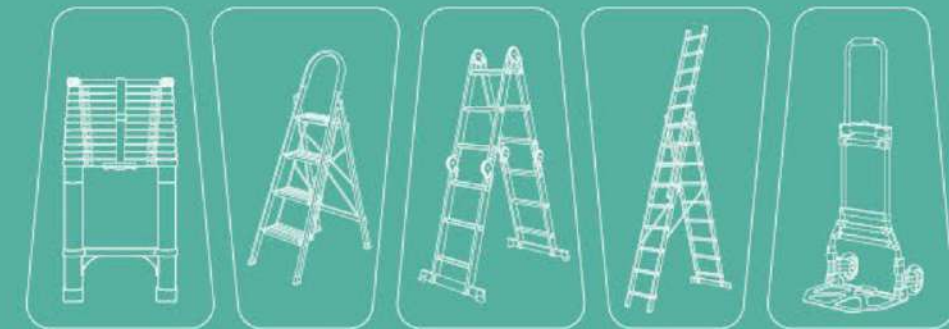

15

15 years focused on
the ladder

EAST WEST CORPORATION LIMITED

Website: WWW.EWCLCHINA.COM

Email : cbgeorge@biznetvigator.com



Table Of Contents

Telescopic ladder series

- 01 Telescopic single ladder
- 07 Telescopic ladder EN131-6
- 08 2 in 1 Telescopic ladders
- 09 Stainless steel 2 in 1 telescopic ladders
- 10 Stainless steel telescopic single ladder

Multi-purpose ladder series

- 11 Multi-purpose ladder

Household ladder series

- 19 Household ladder

Section extension ladder series

- 30 3 Section extension ladder
- 31 2 Section extension ladder
- 32 Fiberglass extension ladder with rope

Steel step ladder series

- 33 Steel step ladder
- 39 Steel ladder
- 41 Working platform

Other ladder series

- 43 Aluminum industrial ladder
- 45 Fiberglass industrial ladder
- 46 Scaffolding ladder

Foldable hand truck series

- 47 Folding luggage cart
- 60 Folding shopping cart
- 61 Folding platform trolley

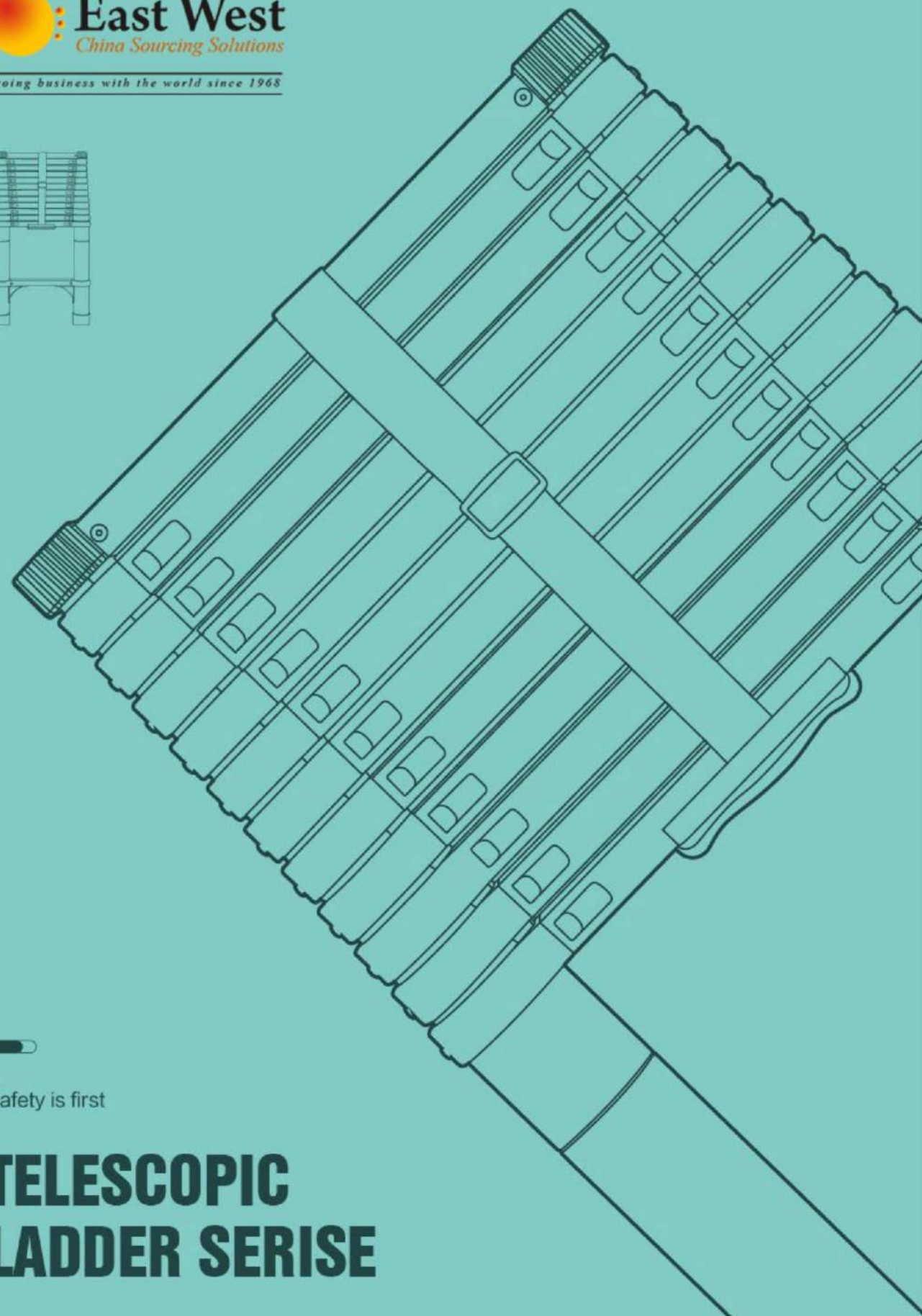
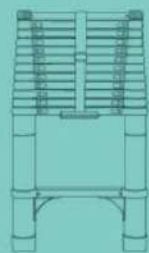

Safety is first

TELESCOPIC LADDER SERISE

TELESCOPIC SINGLE LADDER



Features

1. Multi-time folding with air system inside.
2. Diameter of Top tube:36mm
3. Length of tube:52mm
4. Spacing 30cm,connected up and down tubes overlap 22cm
5. For 3.8m&3.2m fixed with Balance bar, 2.6m without Balance bar
6. Ideal for loft access, cleaning windows, interior and exterior painting and decorating etc.
7. Compact design for easy storage.
8. Lightweight & portable aluminum construction.



Anti slip foot cover



Portable handle



Safety switch

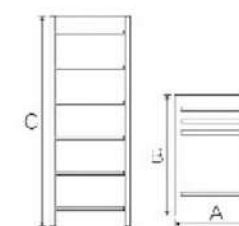

Technical parameters of products

Item No	NO. of Step	Width (cm)	Closed height(cm)	Open height(cm)	N.W (kgs)	Packing Size(cm)	20GP (pcs)	40HQ (pcs)
22-1001A	7	48	68	200	5	68*48*9	980	2400
22-1002A	9	48	75	260	6.8	75*48*9	890	2100
22-1003A	11	50	81	320	8.4	82*50*9.5	790	1900
22-1004A	13	50	87	380	10.7	88*50*9.5	750	1800
22-1005A	14	50	90	410	11.3	91*50*10	700	1600
22-1006A	15	50	93	440	12.3	94*50*10	650	1500

TELESCOPIC SINGLE LADDER



Features

1. Multi-time folding with air system inside.
2. Diameter of Top tube:36mm
3. Length of tube:52mm
4. Spacing 30cm,connected up and down tubes overlap 22cm
5. For 3.8m&3.2m fixed with Balance bar, 2.6m without Balance bar
6. Ideal for loft access, cleaning windows, interior and exterior painting and decorating etc.
7. Compact design for easy storage.
8. Lightweight & portable aluminum construction.
9. 100% all new plastic parts .



Anti-slip step



Safety switch

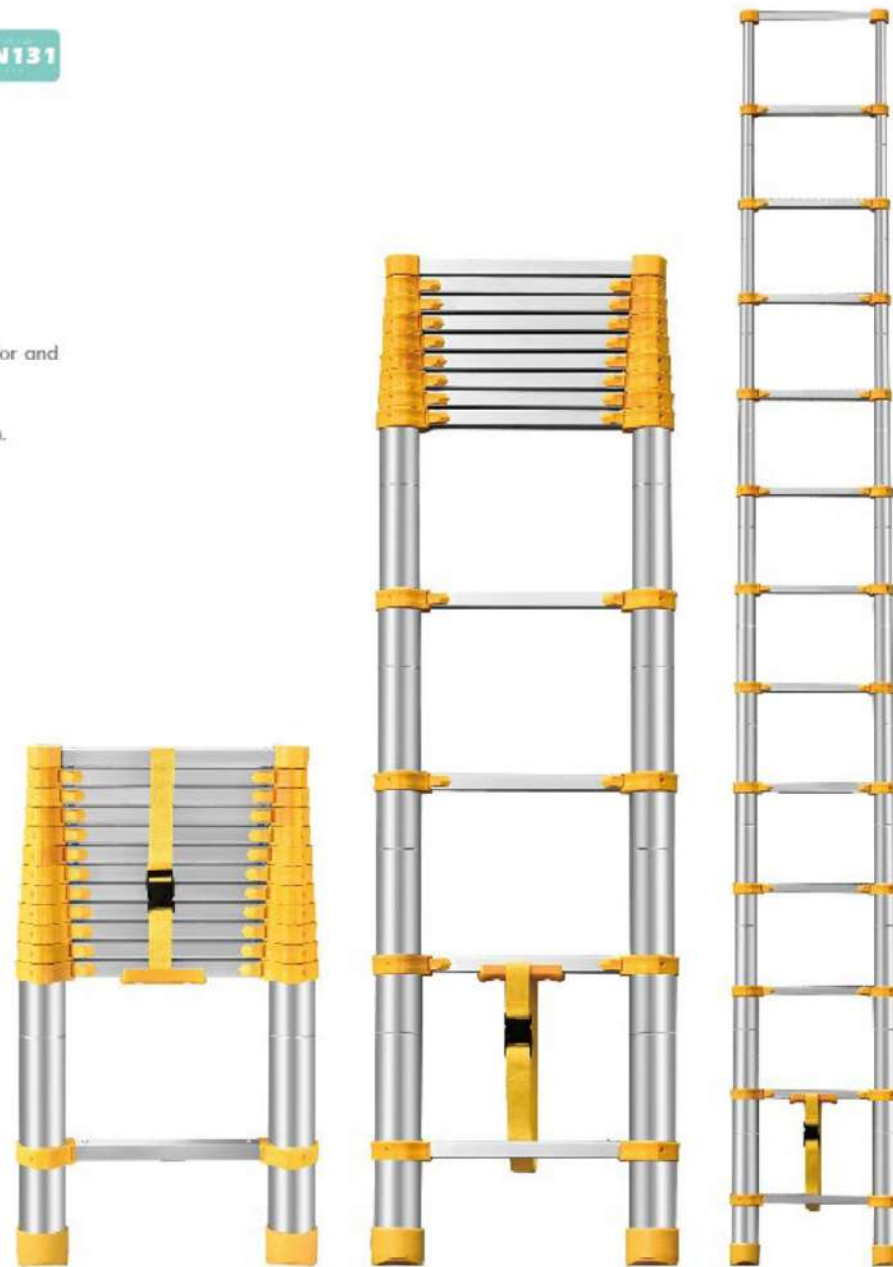
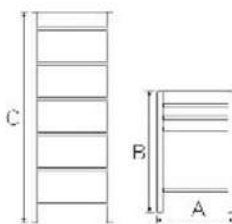

Technical parameters of products

Item No	NO. of Step	Width (cm)	Closed height(cm)	Open height(cm)	N.W (kgs)	Packing Size(cm)	20GP (pcs)	40HQ (pcs)
22-1001E	7	48	68	200	5.7	68*53*13	600	1500
22-1002E	9	48	75	260	7.6	75*53*13	550	1400
22-1003E	11	50	81	320	9.6	82*53*13	500	1250
22-1004E	13	50	87	380	11.6	88*53*13	480	1120
22-1005E	14	50	90	410	12.5	91*53*13	450	1080
22-1006E	15	50	93	440	13.6	94*53*13	420	1040

TELESCOPIC SINGLE LADDER



Features

1. Multi-time folding with air system inside.
2. Diameter of Top tube:36mm
3. Length of tube:52mm
4. Spacing 30cm,connected up and down tubes overlap 22cm
5. For 3.8m&3.2m fixed with Balance bar, 2.6m without Balance bar
6. Ideal for loft access, cleaning windows, interior and exterior painting and decorating etc.
7. Compact design for easy storage.
8. Lightweight & portable aluminum construction.
9. 100% all new plastic parts .



Anti-slip foot cover



Portable handle

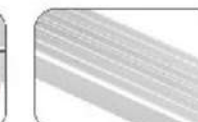

Anti-slip step

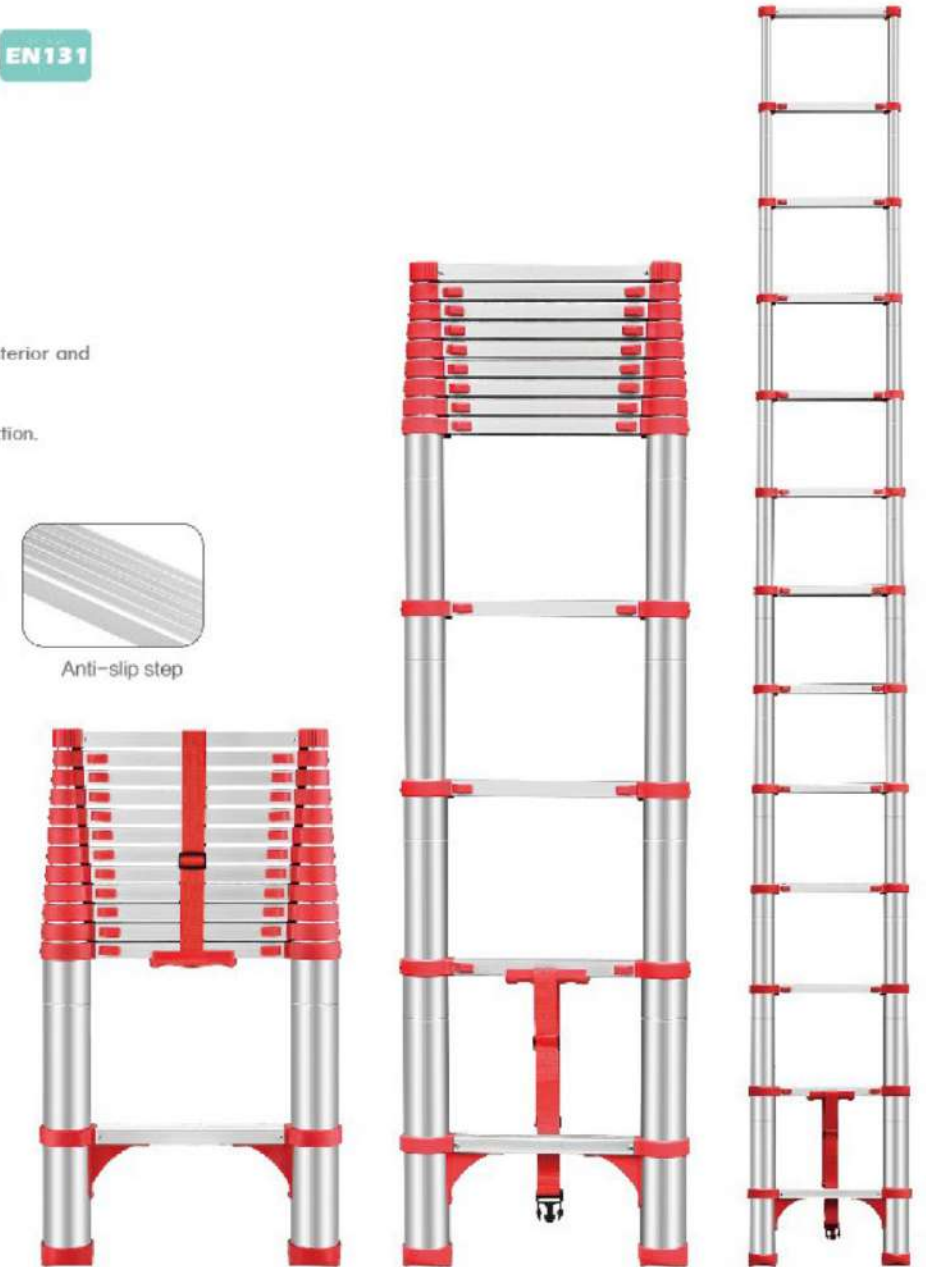
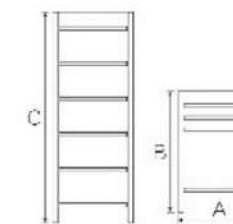

Technical parameters of products

Item No	NO. of Step	Width (cm)	Closed height(cm)	Open height(cm)	N.W (kgs)	Packing Size(cm)	20GP (pcs)	40HQ (pcs)
22-1001A	7	48	68	200	5	68*48*9	980	2400
22-1002A	9	48	75	260	6.8	75*48*9	890	2100
22-1003A	11	50	81	320	8.4	82*50*9.5	790	1900
22-1004A	13	50	87	380	10.7	88*50*9.5	750	1800
22-1005A	14	50	90	410	11.3	91*50*10	700	1600
22-1006A	15	50	93	440	12.3	94*50*10	650	1500



Safety is first

TELESCOPIC SINGLE LADDER SERISE

TELESCOPIC SINGLE LADDER

EN131-6 Approved



Features

1. One-time folding with air system inside.
2. Diameter of Top tube:36mm
3. Length of tube:52mm
4. Spacing 30cm,connected up and down tubes overlap 22cm
5. For 3.8m&3.2m fixed with Balance bar, 2.6m without Balance bar
6. Ideal for loft access, cleaning windows, interior and exterior painting and decorating etc.
7. Compact design for easy storage.
8. Lightweight & portable aluminum construction.



Anti slip foot cover



Portable handle

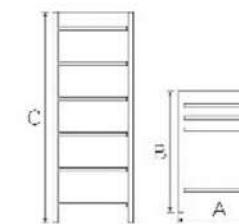

Technical parameters of products

Item No	NO. of Step	Width (cm)	Closed height(cm)	Open height(cm)	N.W (kgs)	Packing Size(cm)	20GP (pcs)	40HQ (pcs)
22-1001N	7	48	72	200	5.7	73*50*10	800	1750
22-1002N	9	48	78	260	7.4	79*50*10	750	1700
22-1003N	10	50	79	290	9.8	80*53*10.5	700	1600
22-1004N	11	50	84	320	10.8	85*53*10.5	660	1500
22-1005N	13	50	90	380	13.1	91*53*10.5	550	1350

TELESCOPIC LADDER EN131-6



Features

1. One-time folding with air system inside.
2. Diameter of Top tube:36mm
3. Length of tube:52mm
4. Spacing 30cm,connected up and down tubes overlap 22cm
5. For 3.8m&3.2m fixed with Balance bar, 2.6m without Balance bar
6. Ideal for loft access, cleaning windows, interior and exterior painting and decorating etc.
7. Compact design for easy storage.
8. Lightweight & portable aluminum construction.

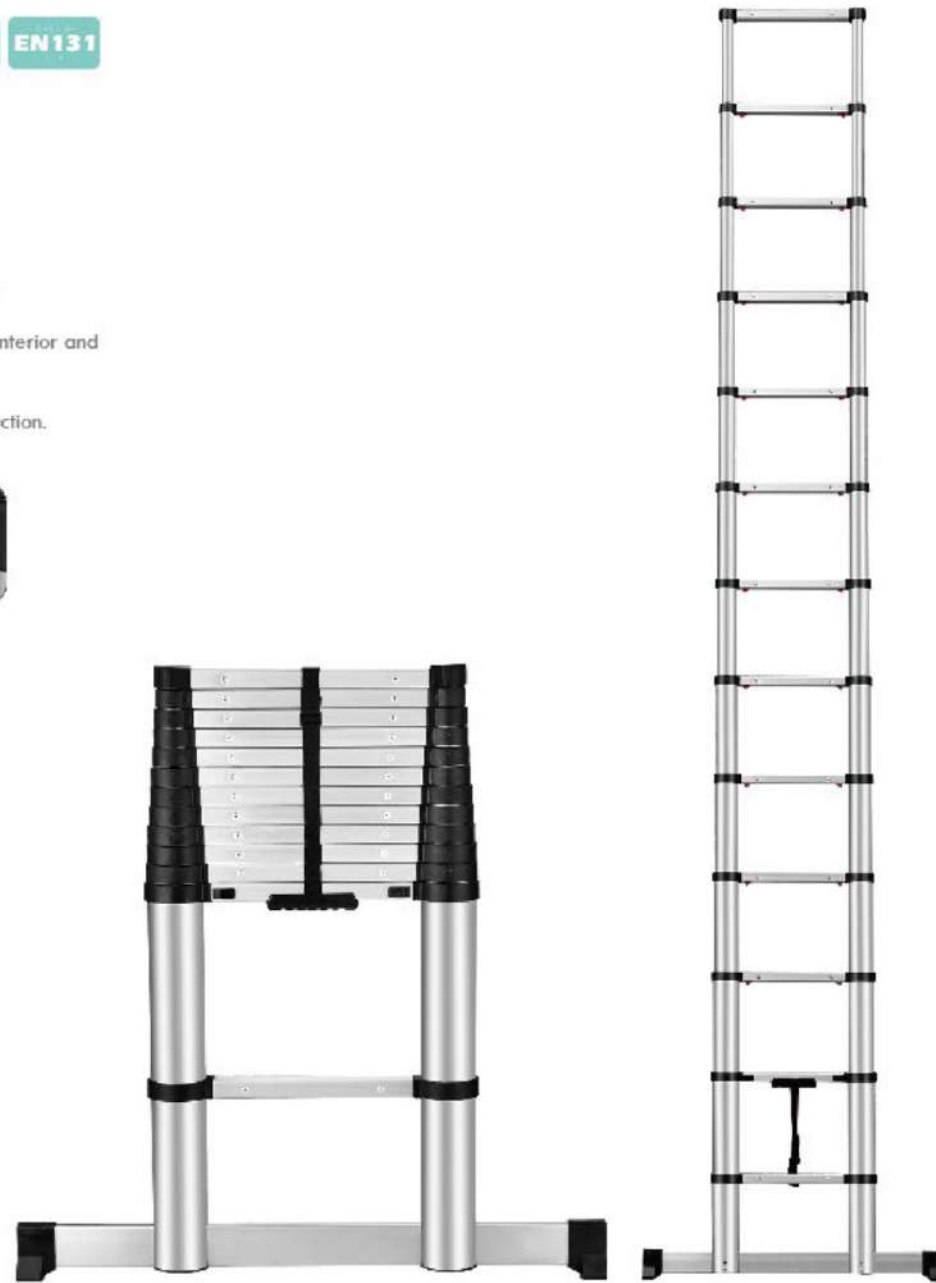
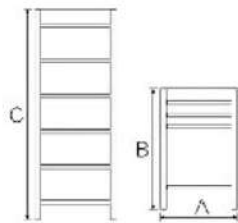

Technical parameters of products

Item No	NO. of Step	Width (cm)	Closed height(cm)	Open height(cm)	N.W (kgs)	Packing Size(cm)	20GP (pcs)	40HQ (pcs)
22-1001N	7	48	72	200	6.3	73*50*10	800	1750
22-1002N	9	48	78	260	7.2	79*50*10	750	1700
22-1003N	10	50	79	290	9.3	80*53*10.5	700	1600
22-1004N	11	50	84	320	10.2	85*53*10.5	660	1500
22-1005N	13	50	90	380	12.3	91*53*10.5	550	1350

2 IN 1 TELESCOPIC LADDERS



Features

1. Ideal for loft access, cleaning windows, interior and exterior painting and decorating etc.
2. Compact design for easy storage.
3. Lightweight & portable aluminum construction.

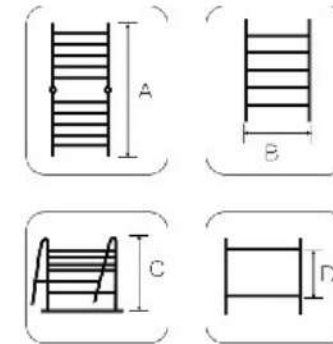

Technical parameters of products

Item No	NO. of Step	Width (cm)	Closed height(cm)	Open height(cm)	N.W (kgs)	Packing Size(cm)	20GP (pcs)	40HQ (pcs)
22-1001D	5+5	50	81	320	11.5	84*52*20	350	820
22-1002D	6+6	50	84	380	13.4	87*52*20	330	760
22-1003D	7+7	50	87	440	15.4	90*52*20	310	700
22-1004D	8+8	50	90	500	17.5	93*52*20	280	680
22-1005D	9+9	50	93	560	19.5	96*52*20	260	660
22-1006D	10+10	50	96	620	21.5	99*52*20	250	630

STAINLESS STEEL 2 IN 1 TELESCOPIC LADDERS

Made by Stainless steel Material



Features

1. Multi-time open & closed system
2. Diameter of Top tube:36mm
3. Length of tube:52mm
4. Spacing 30cm,connected up and down tubes overlap 22cm
5. For 3.8m&3.2m fixed with Balance bar, 2.6m without Balance bar
6. Ideal for loft access, cleaning windows, interior and exterior painting and decorating etc.
7. Compact design for easy storage.
8. Lightweight & portable aluminum construction.



Special big joint



Safety switch

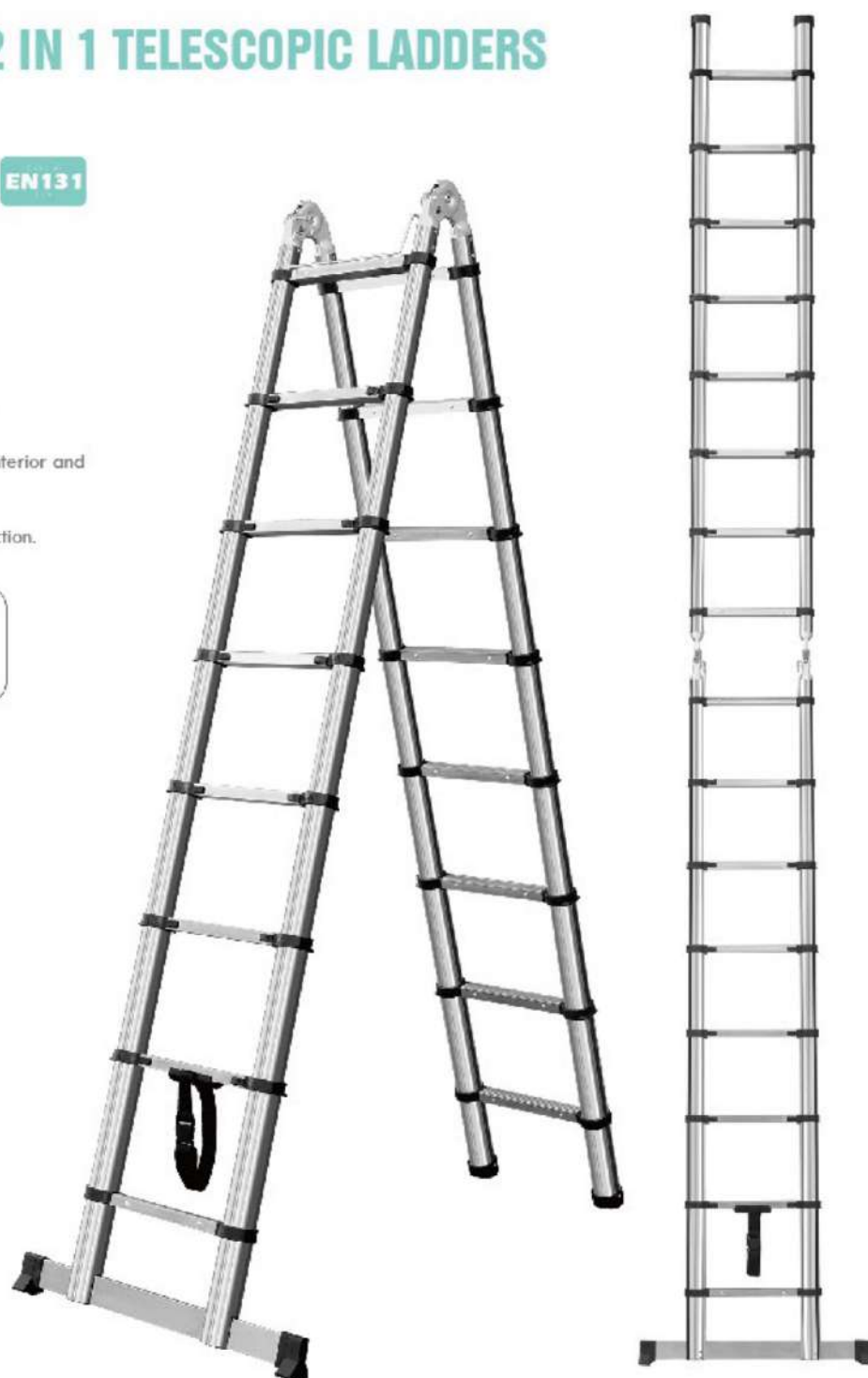
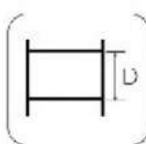
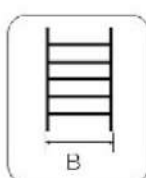
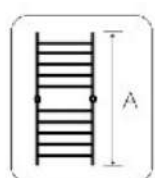

Technical parameters of products

Item No	NO. of Step	Width (cm)	Closed height(cm)	Open height(cm)	N.W (kgs)	Packing Size(cm)	20GP (pcs)	40HQ (pcs)
22-1001D	5+5	50	81	320	13.4	84*52*20	350	820
22-1002D	6+6	50	84	380	16	87*52*20	330	760
22-1003D	7+7	50	87	440	18.6	90*52*20	310	700
22-1004D	8+8	50	90	500	21.2	93*52*20	280	680
22-1005D	9+9	50	93	560	24.2	96*52*20	260	660
22-1006D	10+10	50	96	620	26.8	99*52*20	250	630

STAINLESS STEEL TELESCOPIC SINGLE LADDER

Made by Stainless steel Material



Features

1. Multi-time open & closed system
2. Diameter of Top tube:36mm
3. Length of tube:52mm
4. Spacing 30cm,connected up and down tubes overlap 22cm
5. For 3.8m&3.2m fixed with Balance bar, 2.6m without Balance bar
6. Ideal for loft access, cleaning windows, interior and exterior painting and decorating etc.
7. Compact design for easy storage.
8. Lightweight & portable aluminum construction.



Anti slip foot cover



Portable handle

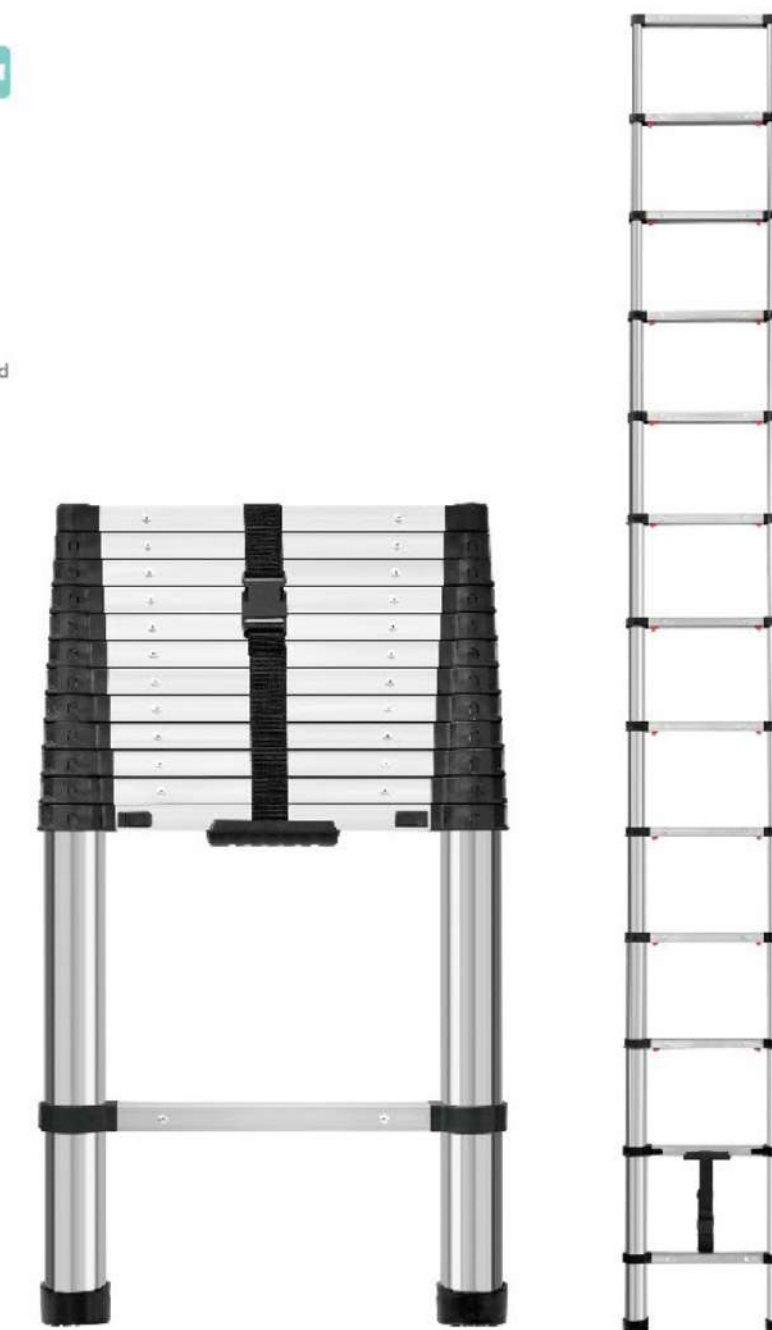
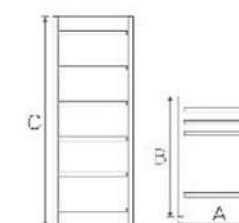

Technical parameters of products

Item No	NO. of Step	Width (cm)	Closed height(cm)	Open height(cm)	N.W (kgs)	Packing Size(cm)	20GP (pcs)	40HQ (pcs)
22-1001A	7	48	68	200	7.0	68*48*9	980	2400
22-1002A	9	48	75	260	8.2	75*48*9	890	2100
22-1003A	11	50	81	320	9.45	82*50*9.5	790	1900
22-1004A	13	50	87	380	11.9	88*50*9.5	750	1800
22-1005A	14	50	90	410	13.1	91*50*10	700	1600
22-1006A	15	50	93	440	14.4	94*50*10	650	1500



150 KG
Max load

Safety is first

MULTI-PURPOSE LADDER SERIES

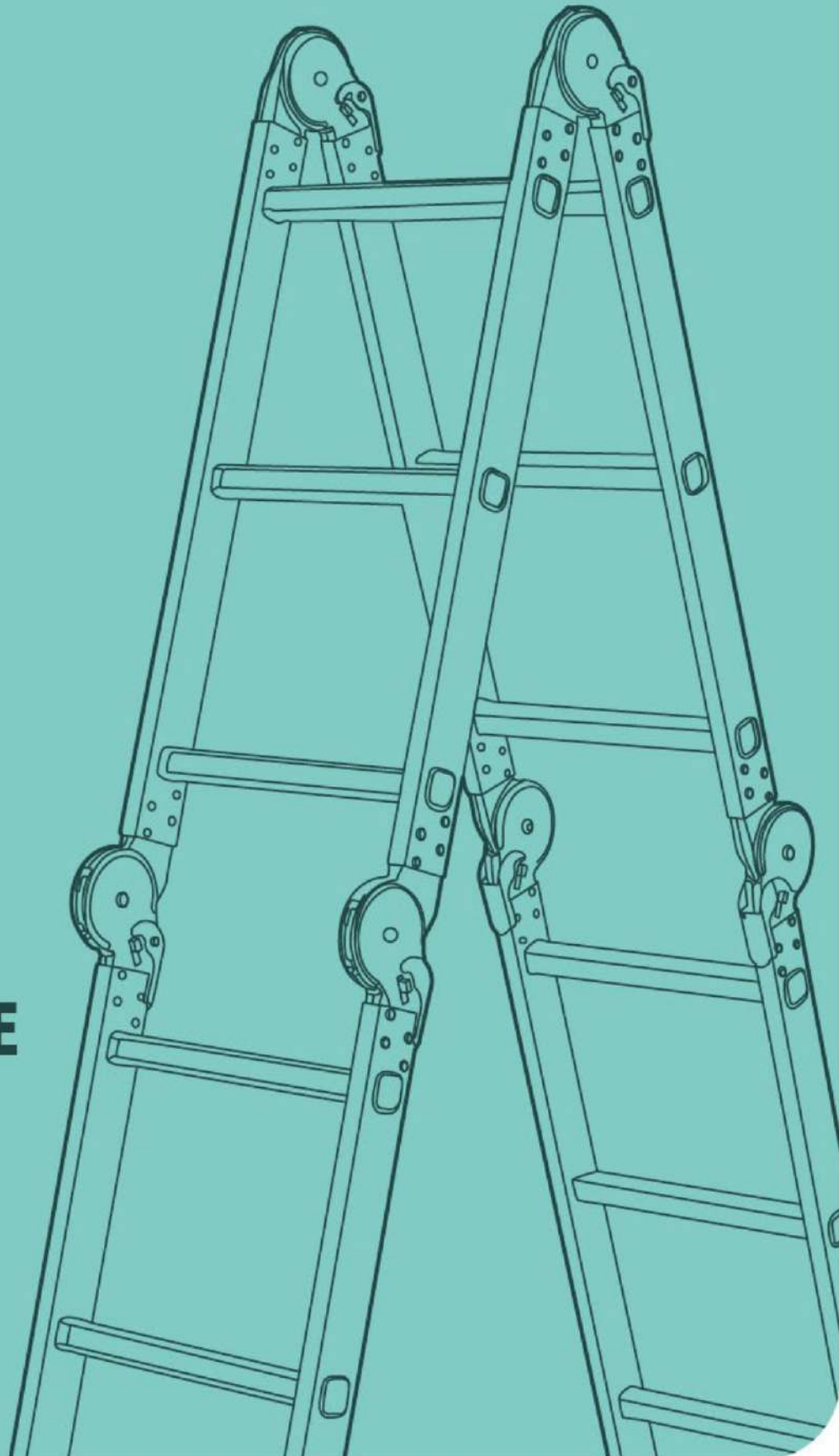

MULTI-PURPOSE LADDER



Features

1. From 4x2 to 4x5, many sizes
2. Ideal for loft access, cleaning windows, interior and exterior painting and decorating etc.
3. Compact design for easy storage.
4. Lightweight & portable aluminum construction.



Small hinge

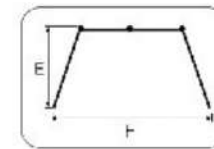
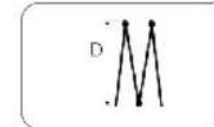
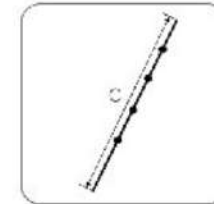
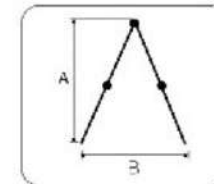

Technical parameters of products

Item No	NO. of Step	A (mm)	B (mm)	C (mm)	D (mm)	E (mm)	F (mm)	N.W (kgs)	Packing Size(cm)	20GP (pcs)	40GP (pcs)	40HQ (pcs)
22-102	4*2	1230	900	2600	720	730	1590	9.8	72*28*38	407	815	943
22-103	4*3	1800	1210	3720	1005	1020	2310	11.02	101*28*38	295	603	681
22-104	4*4	2320	1520	4780	1280	1290	2930	12.65	128*28*38	235	475	537
22-105	4*5	2840	1900	5840	1560	1540	3680	14.2	155*28*37	175	350	425

Safety is first

MULTI-PURPOSE LADDER SERIES

150 KG
Max load



MULTI-PURPOSE LADDER



Features

1. From 4x2 to 4x5, many sizes
2. Ideal for loft access, cleaning windows, interior and exterior painting and decorating etc.
3. Compact design for easy storage.
4. Lightweight & portable aluminum construction.

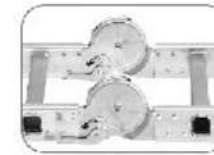

Big hinge

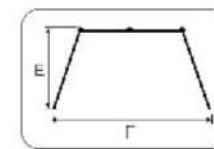
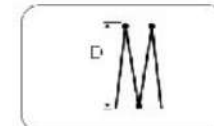
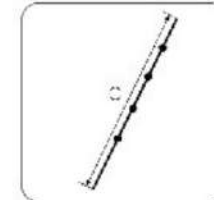
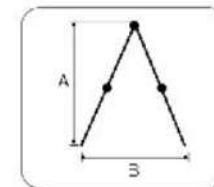

Technical parameters of products

Item No	NO. of Step	A (mm)	B (mm)	C (mm)	D (mm)	E (mm)	F (mm)	N.W (kgs)	Packing Size(cm)	20GP (pcs)	40GP (pcs)	40HQ (pcs)
22-102A	4*2	1200	900	2500	720	730	1580	10.5	68*26*36	480	929	1088
22-103A	4*3	1740	1230	3460	970	960	2210	12.25	95*26*36	330	706	783
22-104A	4*4	2255	1560	4650	1235	1225	2895	13.6	122*26*36	258	529	620
22-105A	4*5	2790	1890	5610	1510	1500	3620	14.7	150*26*36	198	390	495

MULTI-PURPOSE LADDER

Made by aluminum (can painted different color)



Features

1. From 4x2 to 4x5, many sizes
2. Ideal for loft access, cleaning windows, interior and exterior painting and decorating etc.
3. Compact design for easy storage.
4. Lightweight & portable aluminum construction.



Big hinge

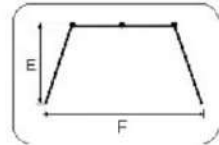
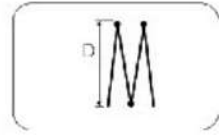
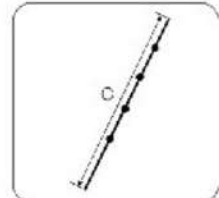
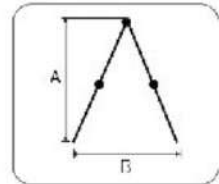

Technical parameters of products

Item No	NO. of Step	A (mm)	B (mm)	C (mm)	D (mm)	E (mm)	F (mm)	N.W (kgs)	Packing Size(cm)	20GP (pcs)	40GP (pcs)	40HQ (pcs)
22-102A	4*2	1200	900	2500	720	730	1580	10.5	68*26*36	480	929	1088
22-103A	4*3	1740	1230	3460	970	960	2210	12.25	95*26*36	330	706	783
22-104A	4*4	2255	1560	4650	1235	1225	2895	13.6	122*26*36	258	529	620

MULTI-PURPOSE LADDER

Made by fiberglass (can be different color)



Features

1. From 4x2 to 4x5, many sizes
2. Ideal for loft access, cleaning windows, interior and exterior painting and decorating etc.
3. Compact design for easy storage.
4. Lightweight & portable fiberglass construction.



Big hinge

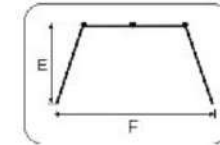
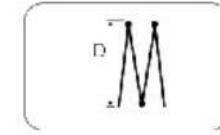
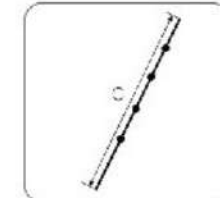
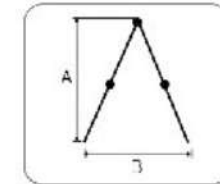

Technical parameters of products

Item No	NO. of Step	A (mm)	B (mm)	C (mm)	D (mm)	E (mm)	F (mm)	N.W (kgs)	Packing Size(cm)	20GP (pcs)	40GP (pcs)	40HQ (pcs)
22-103F	4*3	1740	1230	3460	970	960	2210	13	95*26*36	330	706	783
22-104F	4*4	2255	1560	4650	1235	1225	2895	15	122*26*36	258	529	620

MULTI-PURPOSE LADDER



Features

1. Can be used straight shape and A shape.
2. Non-slip aluminum treads.
3. Flared legs with slip resistant and no necessary to install stabilizer.

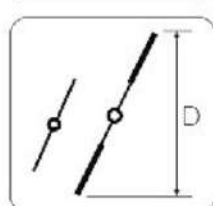
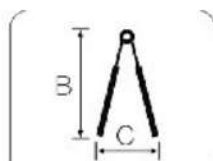
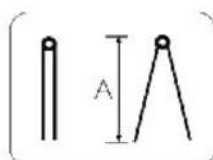

Technical parameters of products

Item No	NO. of Step	A (mm)	B (mm)	C (mm)	D (mm)	N.W (kgs)	Packing Size(cm)	20GP (pcs)	40GP (pcs)	40HQ (pcs)
22-303	4*3	90	143	101	292	8.5	94*18*45	370	740	800
22-304	4*4	116	195	137	402	9.5	122*18*(53+45)	260	520	620
22-305	4*5	142	250	172	515	11.3	150*18*(59+45)	200	400	480
22-306	4*6	168	302	207	627	13.1	178*18*(65+45)	160	320	380
22-307	4*7	194	354	242	739	15	206*18*(71+45)	130	260	320

MULTI-PURPOSE LADDER



Features

1. More than 10 different shape can be used.
2. Non-slip aluminum treads.
3. Flared legs with slip resistant and no necessary to install stabilizer.

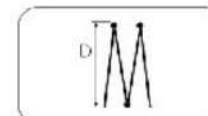
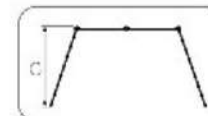
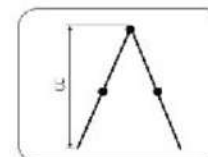
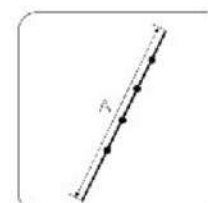

Technical parameters of products

Item No	NO. of Step	A (mm)	B (mm)	C (mm)	D (mm)	N.W (kgs)	Packing Size(cm)	20GP (pcs)	40GP (pcs)	40HQ (pcs)
22-102B	4*2	260	125	70.5	68.5	8.8	70*28*55	320	680	765
22-103B	4*3	360	174	97	98	9.8	98*28*55	235	475	535
22-104B	4*4	468	227	124	126	11.2	126*28*55	190	380	425
22-105B	4*5	580	280	151	154	12.5	154*28*55	160	340	380



Safety is first

HOUSEHOLD LADDER SERIES

150 KG
Max load

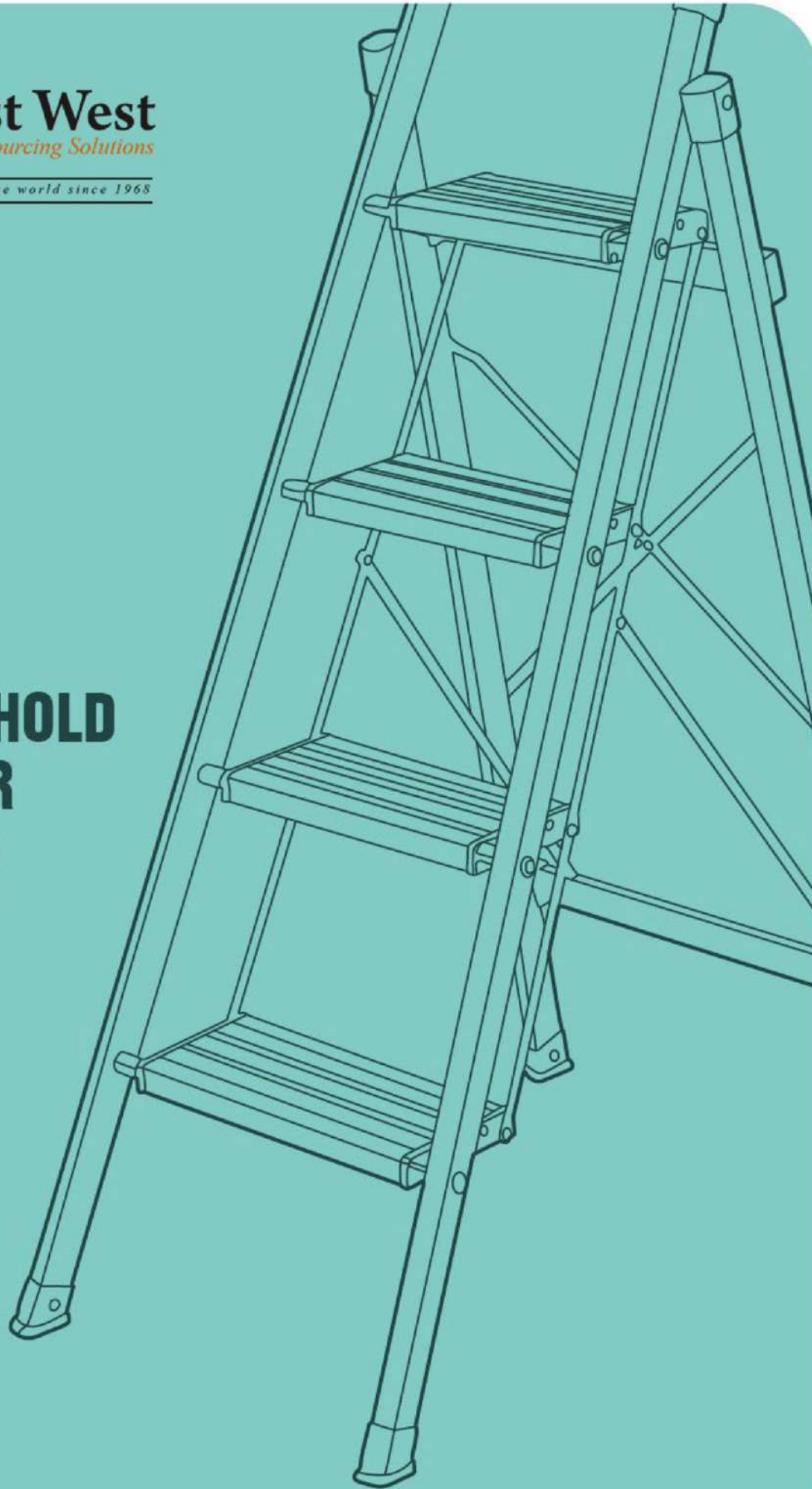

HOUSEHOLD LADDER



Features

1. Ideal for loft access, cleaning windows, interior and exterior painting and decorating etc.
2. Compact design for easy storage.
3. Lightweight & portable aluminum construction.



Top platform can put logo



Anti-slip step

150 KG
Max load

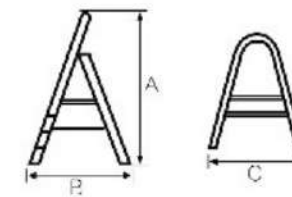

Technical parameters of products

Item No	NO. of Step	A (mm)	B (mm)	C (mm)	N.W (kgs)	Packing Size(cm)	20GP (pcs)	40GP (pcs)	40HQ (pcs)
22 -403	3	1120	590	400	2.7	118*12*40	600	1200	1460
22 -404	4	1320	720	430	3.2	140*12*43	480	960	1160
22 -405	5	1530	850	450	3.67	160*12*45	405	910	980
22 -406	6	1700	950	480	4.2	178*12*49	350	700	840
22 -407	7	1880	960	500	4.75	203*12*50	300	600	740
22 -408	8	2100	1230	520	5.36	223*12*52	260	530	640



Safety is first

HOUSEHOLD LADDER SERIES

150 KG
Max load



HOUSEHOLD LADDER



Features

1. Wooden color more suitable for daily use.
2. Ideal for loft access, cleaning windows, interior and exterior painting and decorating etc.
3. Compact design for easy storage.
4. Lightweight & portable aluminum construction.



Superwide steps



Anti-slip step



Anti-slip foot cover

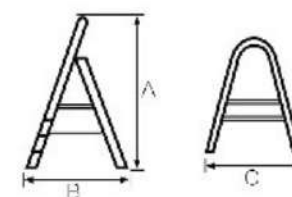

150 KG
Max load

Technical parameters of products

Item No	NO. of Step	A (mm)	B (mm)	C (mm)	N.W (kgs)	Packing Size(cm)	20GP (pcs)	40GP (pcs)	40HQ (pcs)
22-403A	3	1120	590	400	2.7	118*12*40	600	1200	1460
22-404A	4	1320	720	430	3.2	140*12*43	480	960	1160
22-405A	5	1530	850	450	3.67	160*12*45	405	910	980
22-406A	6	1700	950	480	4.2	178*12*49	350	700	840
22-407A	7	1880	960	500	4.75	203*12*50	300	600	740
22-408A	8	2100	1230	520	5.36	223*12*52	260	530	640

HOUSEHOLD LADDER

Made by Aluminum Material



Features

1. Many color can supply: Black/Gold/White silver
2. Non-slip aluminum treads.
3. Flared legs with slip resistant and no necessary to install stabilizer.



Step with rubber anti-slip



Anti-slip foot cover

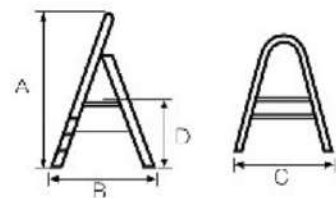

Technical parameters of products

Item No	NO. of Step	A (mm)	B (mm)	C (mm)	D (mm)	N.W (kgs)	Packing Size(cm) 5pcs	20GP (pcs)	40GP (pcs)	40HQ (pcs)
22 -403F	3	1250	620	410	700	3.5	123*48*28	850	1700	2060
22 -404F	4	1480	760	440	950	4.7	148*52*28	650	1300	1600
22 -405F	5	1710	900	470	1200	5.9	173*56*28	520	1040	1250
22 -406F	6	1880	1020	500	1400	7.3	198*60*28	440	880	1000

HOUSEHOLD LADDER

Made by Stainless steel Material



Features

1. Many color can supply: Black/Gold/White silver
2. Ideal for loft access, cleaning windows, interior and exterior painting and decorating etc.
3. Compact design for easy storage.
4. Lightweight & portable aluminum construction.



Step with rubber anti-slip



Anti-slip foot cover

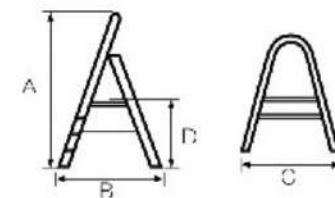

Technical parameters of products

Item No	NO. of Step	A (mm)	B (mm)	C (mm)	D (mm)	N.W (kgs)	Packing Size(cm) 5pcs	20GP (pcs)	40GP (pcs)	40HQ (pcs)
22-403E	3	1250	620	410	700	3.8	123*48*28	850	1700	2060
22-404E	4	1480	760	440	950	5	148*52*28	650	1300	1600
22-405E	5	1710	900	470	1200	6.3	173*56*28	520	1040	1250
22-406E	6	1880	1020	500	1400	7.6	198*60*28	440	880	1000

HOUSEHOLD LADDER



Features

1. Slim design many color can choose.
2. Non-slip aluminum treads.
3. Flared legs with slip resistant and no necessary to install stabilizer.



Step with rubber anti-slip



Anti-slip foot cover



150 KG
Max load

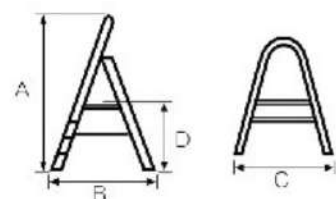

Technical parameters of products

Item No	NO. of Step	A (mm)	B (mm)	C (mm)	D (mm)	N.W (kgs)	Packing Size(cm) 4pcs	20GP (pcs)	40GP (pcs)	40HQ (pcs)
22-402C	2	970	500	450	500	3.4	103*21.5*45	1120	2240	2720
22-403C	3	1235	680	450	765	4.3	129*21.5*45	900	1800	2200
22-404C	4	1435	910	450	970	5.5	155*21.5*45	760	1550	1800

HOUSEHOLD LADDER



Features

1. Slim design many color can choose.
2. Ideal for loft access, cleaning windows, interior and exterior painting and decorating etc.
3. Compact design for easy storage.
4. Lightweight & portable aluminum construction.



Super wide step



Anti-slip cover



150 KG
Max load

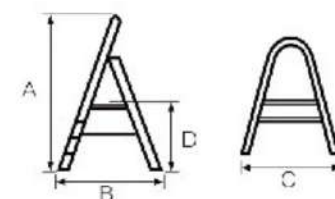

Technical parameters of products

Item No	NO. of Step	A (mm)	B (mm)	C (mm)	D (mm)	N.W (kgs)	Packing Size(cm)	20GP (pcs)	40GP (pcs)	40HQ (pcs)
22-403G	3	1060	640	450	650	4.32	116.5*46*8	650	1340	1580
22-404G	4	1290	815	450	885	5.25	140.5*46*8	530	1110	1300
22-405G	5	1505	1000	450	1000	6.35	164.5*46*8	450	940	1110

HOUSEHOLD LADDER



Features

1. Slim design many color can choose.
2. Non-slip aluminum treads.
3. Flared legs with slip resistant and no necessary to install stabilizer.



Super wide step



Anti-slip cover



150 KG
Max load

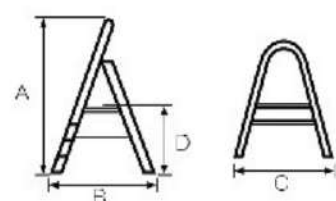

Technical parameters of products

Item No	NO. of Step	A (mm)	B (mm)	C (mm)	D (mm)	N.W (kgs)	Packing Size(cm)	20GP (pcs)	40GP (pcs)	40HQ (pcs)
22-402H	2	610	465	450	440	2.75	66.5*46*7	1270	2630	3080
22-403H	3	810	630	450	650	3.6	95.5*46*7	900	1860	2190
22-404H	4	1030	800	450	875	4.8	116.5*46*7	730	1520	1780

HOUSEHOLD LADDER



Features

1. Slim design many color can choose.
2. Ideal for loft access, cleaning windows, interior and exterior painting and decorating etc.
3. Compact design for easy storage.
4. Lightweight & portable aluminum construction.



Super wide step



Anti-slip cover

150 KG
Max load

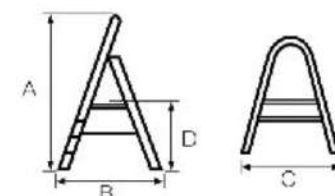

Technical parameters of products

Item No	NO. of Step	A (mm)	B (mm)	C (mm)	D (mm)	N.W (kgs)	Packing Size(cm) 4pcs	20GP (pcs)	40GP (pcs)	40HQ (pcs)
22-402S	2*2	490	430	365	490	6.6	55*38*51	1000	2100	2400
22-403S	2*3	730	610	385	730	9.6	81*40*51	620	1340	1600
22-404S	2*4	970	750	385	970	12.6	107*42*51	460	900	1100
22-405S	2*5	1220	940	420	1220	15.8	133*44*51	340	740	880



Safety is first

SECTION EXTENSION LADDER SERIES

150 KG
Max load



3 SECTION EXTENSION LADDER



Features

1. Each ladder with balance bar.
2. Ideal for loft access, cleaning windows, interior and exterior painting and decorating etc.
3. Free mixed can be 2 layer & 3 layer.
4. Lightweight & portable aluminum construction.

150 KG
Max load

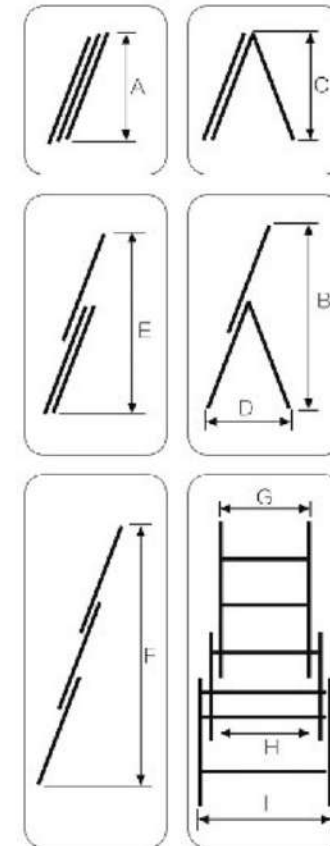

Technical parameters of products

Item No	NO. of Step	A (mm)	B (mm)	C (mm)	D (mm)	E (mm)	F (mm)	NW (kgs)	G/H/I	Packing Size(cm)	20GP (pcs)
22 -606	3*6	1765	2475	1700	1070	2600	3435	9.4	340/400/460	176*46*16	216
22 -607	3*7	2045	3007	1965	1240	3160	4277	10.7	340/400/460	204*46*16	200
22 -608	3*8	2325	3540	2230	1410	3720	5120	11.8	340/400/460	232*46*16	160
22 -609	3*9	2605	4072	2495	1580	4280	5962	13.2	340/400/460	260*46*16	145
22 -610	3*10	2885	4604	2760	1750	4840	6804	14.6	340/400/460	288*46*16	130
22 -611	3*11	3165	5136	3025	1920	5400	7646	15.5	340/400/460	316*46*16	120
22 -612	3*12	3445	5655	3360	2115	5980	8480	17.1	340/400/460	344*46*26	110

2 SECTION EXTENSION LADDER



Features

1. Non-slip aluminum treads.
2. Flared legs with slip resistant and no necessary to install stabilizer.

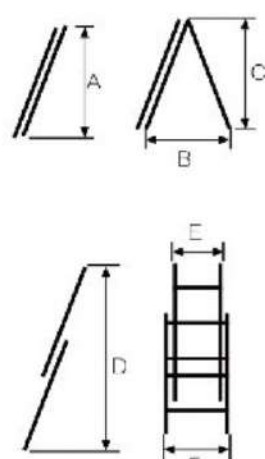

Technical parameters of products

Item No	NO. of Step	A (mm)	B (mm)	C (mm)	D (mm)	E (mm)	F (mm)	N.W (kgs)	Packing Size(cm)	20GP (pcs)	40GP (pcs)
22-806	2*6	1765	1070	1700	2475	380	440	6.2	177*44*16	240	480
22-807	2*7	2045	1370	1950	3035	380	440	6.8	205*44*16	208	416
22-808	2*8	2325	1670	2250	3595	380	440	7.7	232*44*16	184	368
22-809	2*9	2605	1970	2500	4155	380	440	8.6	260*44*16	164	328
22-810	2*10	2885	2270	2800	4715	380	440	9.5	288*44*16	150	300

FIBERGLASS EXTENSION LADDER WITH ROPE



Features

1. Non-slip aluminum treads.
2. Flared legs with slip resistant and no necessary to install stabilizer.



Anti-slip belt



Anti-slip step



Anti-slip foot cover

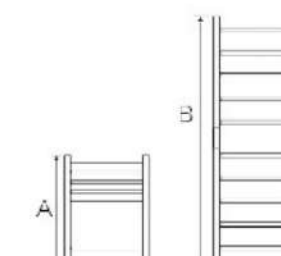
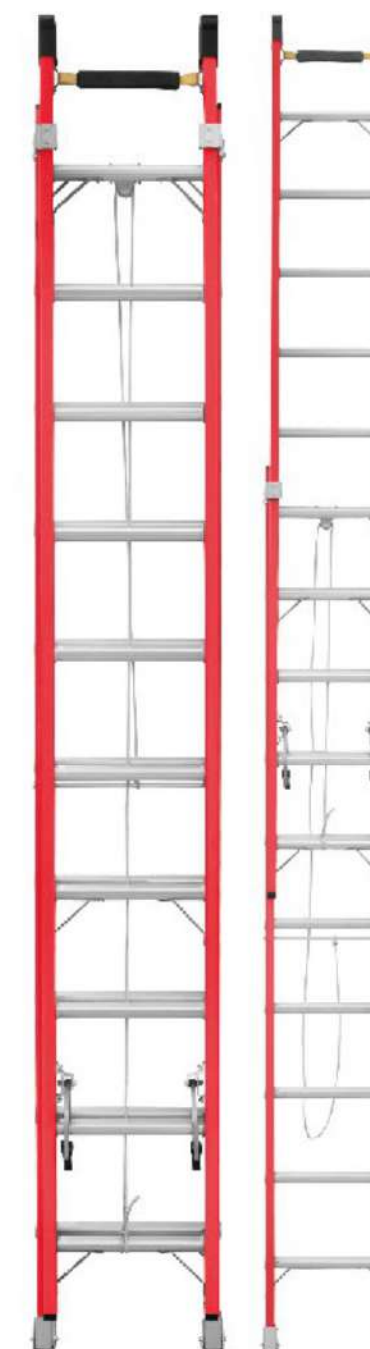

Technical parameters of products

Item No	NO. of Step	A (mm)	B (mm)	N.W (kgs)	Packing Size(cm)	20GP (pcs)	40GP (pcs)	40HQ (pcs)
22S3-44	8+8	2900	4400	15	295*45*16	140	280	300
22S3-56	10+10	3500	5600	18	355*45*16	75	225	245
22S3-68	12+12	4100	6800	21.1	415*45*16	75	150	180
22S3-80	14+14	4700	8000	24.2	475*45*16	75	150	180
22S3-92	16+16	5300	9200	27.3	535*45*16	75	150	180



Safety is first

STEEL STEP LADDER SERIES



STEEL STEP LADDER



Features

1. 100% all new plastic material.
2. Ideal for loft access, cleaning windows, interior and exterior painting and decorating etc.
3. Compact design for easy storage.
4. Lightweight & portable aluminum construction.

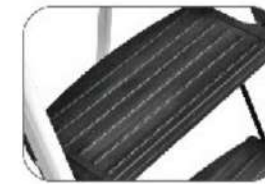

Over sized plastic step

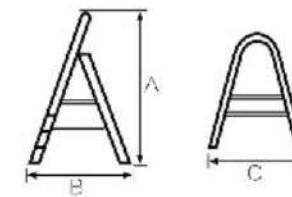

Technical parameters of products

Item No	NO. of Step	A (mm)	B (mm)	C (mm)	N.W (kgs)	Packing Size(cm) 4pcs	20GP (pcs)	40GP (pcs)	40HQ (pcs)
22-1102D	2	965	520	455	3.5	108*28*47	902	1868	2190
22-1103D	3	1210	675	485	4.5	134*28*50	695	1440	1688



Safety is first

STEEL STEP LADDER SERIES



150 KG
Max load

STEEL STEP LADDER



Features

1. 100% all new plastic material.
2. Ideal for loft access, cleaning windows, interior and exterior painting and decorating etc.
3. Compact design for easy storage.
4. Light weight & portable aluminum construction.

150 KG
Max load



38x26cm step size



Anti-slip foot cover

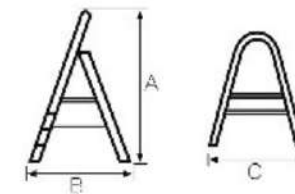

Technical parameters of products

Item No	NO. of Step	A (mm)	B (mm)	C (mm)	N.W (kgs)	Packing Size(cm) 4pcs	20GP (pcs)	40GP (pcs)	40HQ (pcs)
22-1102B	2	780	490	455	4.28	83*46*35	830	1720	2020
22-1103B	3	1035	650	455	6.04	112*46*35	610	1280	1500
22-1104B	4	1290	800	455	7.96	138*46*35	500	1040	1220

STEEL STEP LADDER



Features

1. 100% all new plastic material.
2. Ideal for loft access, cleaning windows, interior and exterior painting and decorating etc.
3. Compact design for easy storage.
4. With handrail more safe



38x26cm step size



Anti-slip foot cover



150 kg
Max load

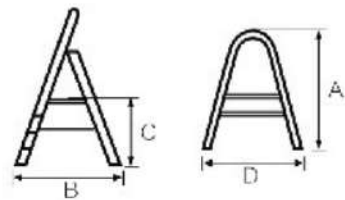

Technical parameters of products

Item No	NO. of Step	A (mm)	B (mm)	C (mm)	D (mm)	N.W (kgs)	Packing Size(cm) 2pcs	20GP (pcs)	40GP (pcs)	40HQ (pcs)
22-1203A	3	1325	670	715	470	7.3	143*48*20.5	380	790	930
22-1204A	4	1530	980	780	470	9.4	165*48*20.5	340	680	800

STEEL STEP STOOL



Features

1. 100% all new plastic material.
2. Ideal for loft access, cleaning windows, interior and exterior painting and decorating etc.
3. Compact design for easy storage.
4. Light weight & portable aluminum construction.



Anti-slip foot cover



150 kg
Max load

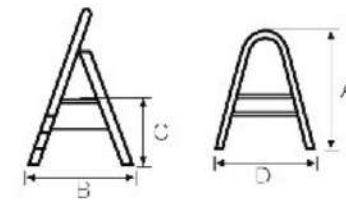

Technical parameters of products

Item No	NO. of Step	A (mm)	B (mm)	C (mm)	D (mm)	N.W (kgs)	Packing Size(cm) 10pcs	20GP (pcs)	40GP (pcs)	40HQ (pcs)
22-1102C	2	255	370	255	445	2.34	37*44.5*85	1800	4000	4600
22-1103C	3	380	640	380	445	3.93	64*44.5*100	900	1800	2100

STEEL LADDER



Features

1. 100% all new plastic material.
2. Ideal for loft access, cleaning windows, interior and exterior painting and decorating etc.
3. Compact design for easy storage.
4. Lightweight & portable aluminum construction.



Wide pedal



Anti-slip shoes

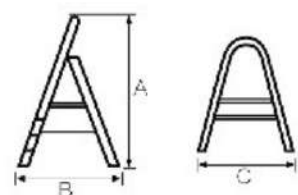

Technical parameters of products

Item No	NO. of Step	A (mm)	B (mm)	C (mm)	N.W (kgs)	Packing Size(cm) 4pcs	20GP (pcs)	40GP (pcs)	40HQ (pcs)
22-1102E	2	810	470	470	3.8	88*48*30	800	1700	2100
22-1103E	3	1040	610	470	5.1	114*48*30	600	1300	1600

STEEL LADDER



Features

1. 100% all new plastic material.
2. Ideal for loft access, cleaning windows, interior and exterior painting and decorating etc.
3. Compact design for easy storage.
4. Lightweight & portable aluminum construction.



Anti-slip shoes

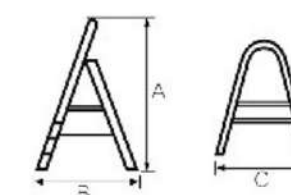

Technical parameters of products

Item No	NO. of Step	A (mm)	B (mm)	C (mm)	N.W (kgs)	Packing Size(cm)	20GP (pcs)	40GP (pcs)	40HQ (pcs)
22-1402	2	785	540	460	4.1	89*28*46.6/6PCS	1542	3084	3516
22-1403	3	1030	620	470	5.4	112*19*48/4PCS	1144	2288	2728
22-1404	4	1270	815	480	6.9	137*21*47/4PCS	872	1744	2092

WORKING PLATFORM



Features

1. Portable, light weight, easy to carry and set up, convenient to store. Slip-resistant provides a non-skid area for standing.
2. Non-marring provides slip-resistance and protects floor from damage.

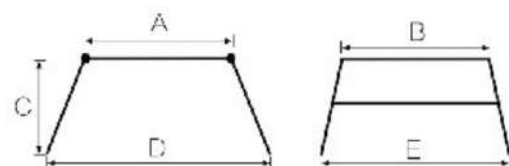

Technical parameters of products

Item No	A (mm)	B (mm)	C (mm)	D (mm)	E (mm)	N.W (kgs)	Packing Size(cm)	20GP (pcs)	40GP (pcs)	40HQ (pcs)
22-205	950	300	495	1280	380	7.2	100*39*20	369	700	837
22-205A	950	300	495	1280	380	7.8	100*39*20	369	700	837

WORKING PLATFORM



Features

1. Portable, light weight, easy to carry and set up, convenient to store. Slip-resistant provides a non-skid area for standing.
2. Non-marring provides slip-resistance and protects floor from damage.

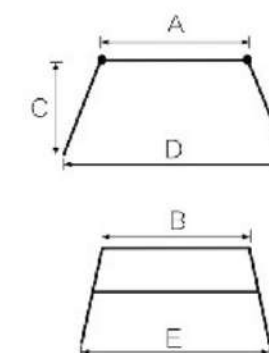

Technical parameters of products

Item No	A (mm)	B (mm)	C (mm)	D (mm)	E (mm)	N.W (kgs)	Packing Size(cm)	20GP (pcs)	40GP (pcs)	40HQ (pcs)
22-202	860	300	500	1240	420	5.2	90*17*40	440	860	1110
22-202A	860	300	600	1300	420	5.5	90*17*42	420	840	1080
22-203	760	300	490	1060	420	3.6	78*14*40	586	1230	1440
22-203A	760	300	590	1120	420	3.9	78*14*42	566	1200	1400

ALUMINUM INDUSTRIAL LADDER



Features

1. Ideal for loft access, cleaning windows, interior and exterior painting and decorating etc.
2. Compact design for easy storage.
3. Lightweight & portable aluminum construction.



Top tools plate



Side tools plate



Anti-slip cover

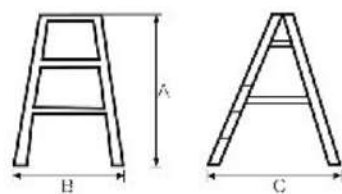

Technical parameters of products

Item No	NO. of Step	A (mm)	B (mm)	C (mm)	N.W (kgs)	Packing Size(cm)	20GP (pcs)	40GP (pcs)	40HQ (pcs)
22-1504D	2*4	1120	467	800	3.8	127.5*13.5*46.7	410	820	982
22-1505D	2*5	1410	504	1000	4.8	158*13.5*50.4	305	610	737
22-1506D	2*6	1700	541	1200	5.5	188.5*13.5*54.1	235	470	567
22-1507D	2*7	1985	578	1400	6.2	216.5*13.5*57.8	210	420	505

ALUMINUM INDUSTRIAL LADDER



Features

1. Ideal for loft access, cleaning windows, interior and exterior painting and decorating etc.
2. Compact design for easy storage.
3. Lightweight & portable aluminum construction.



Anti-slip step



Anti-slip cover

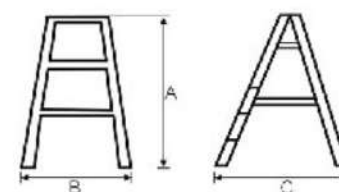

Technical parameters of products

Item No	NO. of Step	A (mm)	B (mm)	C (mm)	D (mm)	N.W (kgs)	Packing Size(cm) 10pcs	20GP (pcs)	40GP (pcs)	40HQ (pcs)
22-1506A	6	1668	486	1126	3200	6.4	48.6*14*183.7	277	563	658
22-1507A	7	1946	520	1308	3787	7.5	52*14*213.7	230	467	547
22-1508A	8	2224	555	1489	4374	8.6	55.5*14*243.7	194	394	461
22-1509A	9	2502	590	1671	4961	9.7	59*14*273.5	166	337	395
22-1510A	10	2780	624	1852	5548	10.9	62.4*14*303.7	144	293	343
22-1511A	11	3058	658	2044	6143	12.1	65.8*14*333.7	120	240	300
22-1512A	12	3336	693	2225	6730	13.5	69.3*14*363.7	112	229	267
22-1513A	13	3615	728	2405	7023.5	15	72.8*14*393.5	100	200	240
22-1514A	14	3892	762	2588	7317	16.5	76.2*14*423.7	90	180	214

FIBERGLASS INDUSTRIAL LADDER



Features

1. Ideal for loft access, cleaning windows, interior and exterior painting and decorating etc.
2. Compact design for easy storage.
3. Lightweight & portable aluminum construction.



Top tools plate



Anti-slip step



Anti-slip cover

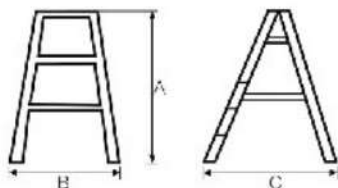

Technical parameters of products

Item No	NO. of Step	A (mm)	B (mm)	C (mm)	N.W (kgs)	Packing Size(cm)	20GP (pcs)	40GP (pcs)	40HQ (pcs)
22-1505B	5	1560	510	1060	6.4		200	420	480
22-1506B	6	1830	550	1230	7.3		160	320	380
22-1507B	7	2100	580	1390	8.5		130	260	310
22-1508B	8	2370	620	1570	9.7		110	220	260
22-1509B	9	2640	650	1730	10.9		90	180	220
22-1510B	10	2910	690	1900	12.3		80	160	180

SCAFFOLDING LADDER



Features

1. Ideal for loft access, cleaning windows, interior and exterior painting and decorating etc.
2. Compact design for easy storage.
3. Lightweight & portable aluminum construction.

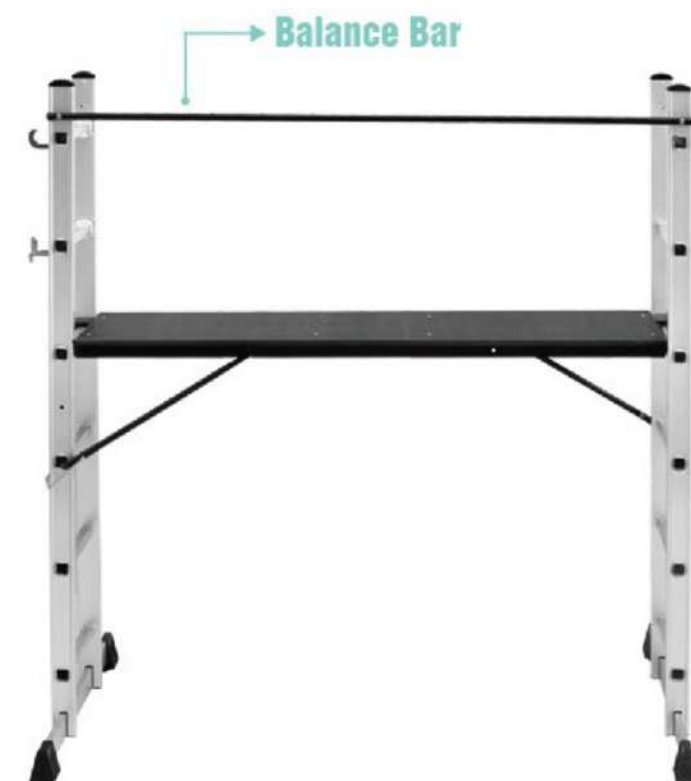
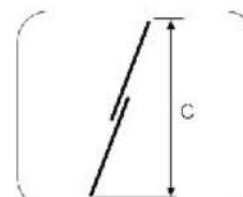
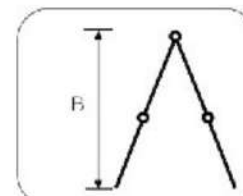
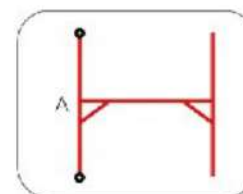

Technical parameters of products

Item No	NO. of Step	A (mm)	B (mm)	C (mm)	N.W (kgs)	Platform Size(cm)	Packing Size(cm)	20GP (pcs)	40GP (pcs)	40HQ (pcs)
22-1105	2*5	1400	1200	198	17	147*40.5	177*44*16	254	590	650
22-1106	2*6	1680	1450	2520	18	147*40.5	205*44*16	220	510	550
22-1107	2*7	1960	1700	3060	19	147*40.5	232*44*16	230	460	530
22-1106A	2*6	1680	1450	2520	18.5	147*40.5	205*44*16	220	510	550
22-1107A	2*7	1960	1700	3060	19.5	147*40.5	232*44*16	230	460	530



FOLDING HAND TRUCK SERIES

FOLDABLE HAND TRUCK

Features

1. Convenient folding/aluminum alloy body/practical and durable
2. Bearing capacity of more than 200 catties
3. The wheel is resistant to pressure and wear, suitable for a variety of road surface, durable, long service life

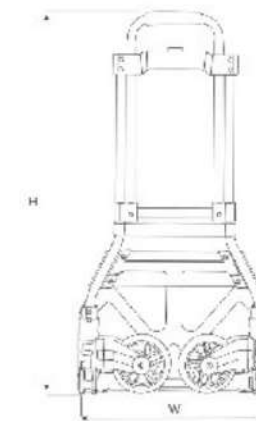
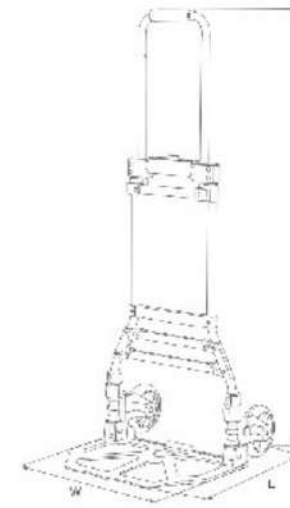

Technical parameters of products

Item No	22-RA90S
Folder size: 395*770*60mm	Tube diameter: 22*1.8mm
Open size: 410*400*1020mm	Export size: 80*41*25cm/4pcs
Material: Aluminum steel pp tpr	N.W. / G.W.: 3.46 /15.2kgs
Foot plate: 390*280mm	Standard packing: Each one /shrink bag,with color card ,4 pcs per carton
Wheel size: 125mm	20GP/40HQ: 1360/3360 pcs

FOLDABLE HAND TRUCK

Features

1. Convenient folding/aluminum alloy body/practical and durable
2. Bearing capacity of more than 200 catties
3. The wheel is resistant to pressure and wear, suitable for a variety of road surface, durable, long service life

70 KG
Max load



Technical parameters of products

Item No	22-GZS90A
Folder size: 395*190*710mm	Export size: 74*42*25cm/4pcs
Open size: 395*410*1080mm	N.W./G.W.: 4.4/19kgs
Material: Aluminum steel pp eva	Standard packing: Each one /shrink bag,with color card ,4 pcs per carton
Foot plate: 355*240mm	20GP/40HQ: 1000/3200 pcs
Wheel size: 150mm	

FOLDABLE HAND TRUCK

Features

1. Convenient folding/aluminum alloy body/practical and durable
2. Bearing capacity of more than 200 catties
3. The wheel is resistant to pressure and wear, suitable for a variety of road surface, durable, long service life

70 KG
Max load



Technical parameters of products

Item No	22-RA60A
Folder size: 640*385*55mm	Wheel size: 150mm*28mm
Open size: 410*385*985mm	Export size: 66*40*31cm/6pcs
Material: frame: Aluminum tube	N.W./G.W.: 2.8/18kgs
Foot plate: aluminum	Standard packing: Each one /shrink bag,with color card ,6 pcs per carton
Foot plate: 385*280mm	20GP/40HQ: 1900/4980 pcs

FOLDING LUGGAGE CART

Features

1. Convenient folding/aluminum alloy body/practical and durable
2. Bearing capacity of more than 200 catties
3. The wheel is resistant to pressure and wear, suitable for a variety of road surface, durable, long service life

30 KG
Max load



Technical parameters of products

Item No	22-GZS30
Folder size: 445*230*83mm	Wheel size: 75mm*22mm(pp+pvc)
Open size: 320*230*965mm	Export size: 48*24.5*45cm/8pcs
Material: Frame : Steel tube	N.W./G.W.: 1.25/11.2kgs
Foot plate: Plastic	Standard packing: Each one /shrink bag,with color card ,8 pcs per carton .
Foot plate: 320*230mm	20GP/40HQ: 4280/10200 pcs

FOLDING LUGGAGE CART

Features

1. Convenient folding/aluminum alloy body/practical and durable
2. Bearing capacity of more than 200 catties
3. The wheel is resistant to pressure and wear, suitable for a variety of road surface, durable, long service life

120 KG
Max load



Technical parameters of products

Item No	22-GZS120A
Folder size: 485*60*905mm	Wheel size: 175mm*35mm(pp+tpr)
Open size: 485*520*1195mm	Export size: 91.5*30*50cm/4pcs
Material: Frame : Steel tube	N.W./G.W.: 5.1/22kgs
Foot plate: Plastic	Standard packing: Each one /shrink bag,with color card ,4 pcs per carton
Foot plate: 350*485mm	20GP/40HQ: 900/2100pcs

FOLDING LUGGAGE CART

Features

1. Convenient folding/aluminum alloy body/practical and durable
2. Bearing capacity of more than 200 catties
3. The wheel is resistant to pressure and wear, suitable for a variety of road surface, durable, long service life

200 KG
Max load



Technical parameters of products

Item No	22-GZS200A
Folder size: 590*90*1075mm	Wheel size: 200mm*44mm(pp+tpr)
Open size: 590*610*1310mm	Export size: 60*10*106cm/1pc
Material: Frame : Aluminum tube	N.W./G.W.: 11/13kgs
Foot plate: Plastic	Standard packing: Each one /shrink bag,with color card ,1 pcs per carton
Foot plate: 350*490mm	20GP/40HQ: 440/1080pcs

FOLDING LUGGAGE CART

Features

1. Convenient folding/aluminum alloy body/practical and durable
2. Bearing capacity of more than 200 catties
3. The wheel is resistant to pressure and wear, suitable for a variety of road surface, durable, long service life

120 KG
Max load



Technical parameters of products

Item No	22-GZS120S
Folder size: 485*60*905mm	Wheel size: 175mm*35mm(pp+tpr)
Open size: 485*520*1195mm	Export size: 91.5*30*50cm/4pcs
Material: Frame : Steel tube	N.W./G.W.: 5.1/22kgs
Foot plate: Plastic	Standard packing: Each one /shrink bag,with color card ,4 pcs per carton
Foot plate: 350*485mm	20GP/40HQ: 900/2100pcs

FOLDING LUGGAGE CART

Features

1. Convenient folding/aluminum alloy body/practical and durable
2. Bearing capacity of more than 200 catties
3. The wheel is resistant to pressure and wear, suitable for a variety of road surface, durable, long service life

30 KG
Max load



Technical parameters of products

Item No	22 -GZS30ST
Folder size: 370*11*715mm	Wheel size: 100mm*20mm(pp+tp)
Open size: 370*430*930mm	Export size: 77*38*23cm/4pcs
Material: Frame : Steel tube (powder coating)	N.W./G.W.: 2.5/11.3kgs
Foot plate: Steel	Standard packing: Each one /shrink bag,with color card ,4 pcs per carton
Foot plate: 340*295mm	20GP/40HQ: 1600/3800pcs

FOLDING LUGGAGE CART

Features

1. Convenient folding/aluminum alloy body/practical and durable
2. Bearing capacity of more than 200 catties
3. The wheel is resistant to pressure and wear, suitable for a variety of road surface, durable, long service life

80 KG
Max load



Technical parameters of products

Item No	22 -GZS68ST
Folder size: 385*50*760mm	Wheel size: 125mm*26mm(pp+tp)
Open size: 390*400*995mm	Export size: 77*40*21cm/4pcs
Material: Frame : steel tube (powder coating)	N.W./G.W.: 3.9/17.5gs
Foot plate: steel	Standard packing: Each one /shrink bag,with color card ,4 pcs per carton
Foot plate: 385*265mm	20GP/40HQ: 1800/4200pcs

FOLDING LUGGAGE CART

Features

1. Convenient folding/aluminum alloy body/practical and durable
2. Bearing capacity of more than 200 catties
3. The wheel is resistant to pressure and wear, suitable for a variety of road surface, durable, long service life

70 KG
Max load



Technical parameters of products

Item No	22-RA60B
Folder size: 640*385*55mm	Wheel size: 150mm*28mm
Open size: 410*385*985mm	Export size: 66*40*31cm/6pcs
Material: Frame : Aluminum tube	N.W./G.W.: 2.95/18.5kgs
Foot plate: Aluminum	Standard packing: Each one /shrink bag,with color card ,6 pcs per carton
Foot plate: 385*280mm	20GP/40HQ: 1900/4980 pcs

FOLDING LUGGAGE CART

Features

1. Convenient folding/aluminum alloy body/practical and durable
2. Bearing capacity of more than 200 catties
3. The wheel is resistant to pressure and wear, suitable for a variety of road surface, durable, long service life

150 KG
Max load



Technical parameters of products

Item No	22-RA150
Folder size: 770*480*55mm	Wheel size: 170mm*30mm
Open size: 530*490*1080mm	Export size: 76*47*6cm/2pc
Material: Frame : Aluminum tube	N.W./G.W.: 5.3/12.4kgs
Foot plate: Aluminum	Standard packing: Each one /shrink bag,with color card ,2 pcs per carton
Foot plate: 485*320mm	20GP/40HQ: 1300/3200 pcs

FOLDING LUGGAGE CART

Features

1. Convenient folding/aluminum alloy body/practical and durable
2. Bearing capacity of more than 200 catties
3. The wheel is resistant to pressure and wear, suitable for a variety of road surface, durable, long service life

150 KG
Max load



Technical parameters of products

Item No	22-JZS150N
Folder size: 420*530*230mm	Wheel size: 100mm*30mm
Open size: 420*710*950mm	Export size: 54*43*12cm/1 pc
Material: Frame : Aluminum tube+steel tube	N.W./G.W.: 7.6/9kgs
Foot plate: Aluminum	Standard packing: Each one /shrink bag,with color card ,1 pcs per carton
Foot plate: 485*320mm	20GP/40HQ: 500/1200 pcs

FOLDING SHOPPING CART

35 KG
Max load



Technical parameters of products

Item No	22-RA35
Folder size: 460*510*80mm	Wheel size: 85mm*25mm
Open size: 430*360*1000mm	Export size: 47*52*46cm/5pc
Material: Frame : Aluminum tube	N.W./G.W.: 2.8/3.5kgs
Foot plate: Plastic	Standard packing: Each one /shrink bag,with color card ,5 pcs per carton
Foot plate: 430*360mm	20GP/40HQ: 1200/2800 pcs

FOLDING PLATFORM TROLLEY

Features

1. Convenient folding/aluminum alloy body/practical and durable
2. Bearing capacity of more than 200 catties
3. The wheel is resistant to pressure and wear, suitable for a variety of road surface, durable, long service life



PZS300



PZS150

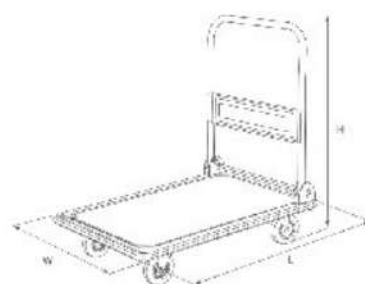

Technical parameters of products

Item No	22S150	22S300
Folder size:	715*480*115mm	715*480*115mm
Open size:	715*480*850mm	715*480*850mm
Material:	Frame: Steel tube	Frame: Steel tube
Foot plate:	Steel	Steel
Foot plate:	715*480mm	715*480mm
Wheel size:	100mm*30mm	100mm*30mm
Export size:	73.5*48*11.5/1pc	73.5*48*11.5/1pc
N.W./G.W.:	8.3/9.5kgs	8.3/9.5kgs
Standard packing:	Each one /shrink bag,with color card ,1 pcs per carton	Each one /shrink bag,with color card ,1 pcs per carton
20GP/40HQ:	980/2100 pcs	980/2100 pcs

FOLDING PLATFORM TROLLEY

Features

1. Convenient folding/aluminum alloy body/practical and durable
2. Bearing capacity of more than 200 catties
3. The wheel is resistant to pressure and wear, suitable for a variety of road surface, durable, long service life



Technical parameters of products

Item No	22S90
Folder size:	720*480*125mm
Open size:	720*480*820mm
Material:	Frame : Steel tube
Foot plate:	Plastic
Foot plate:	720*480mm
Wheel size:	100mm*30mm
Export size:	73.5*48*13/6 cm/1pc
N.W./G.W.:	7.0/8.5kgs
Standard packing:	Each one /shrink bag,with color card ,1 pcs per carton
20GP/40HQ:	950/2000 pcs